

UNIVERSAL CONCENTRIC VENT KIT (UCVK™) CONFIGURATION GUIDE

1) The UCVK™ comes assembled in the box for a venting system with a left hand side configuration (Figure 1). If your system is set up as a left hand configuration skip to step 7.

Determine Configuration

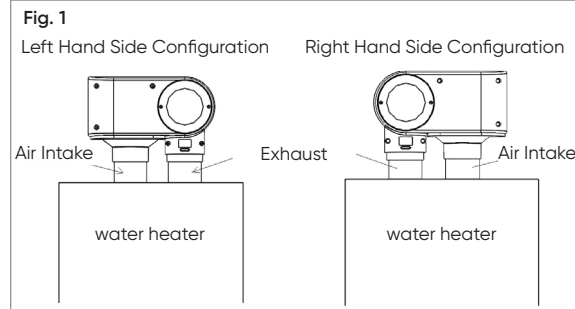

Remove Pipe Socket & Access Panel

2) If the venting system has a right hand side configuration start by removing the 2 screws on the Access Panel and the Pipe Socket Ring (Figure 2)

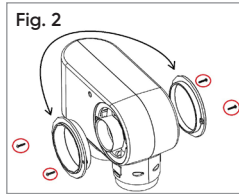

3) Next remove the remaining 5 front screws and separate both sides of the casing (Figure 3), providing access to the inside of the unit.

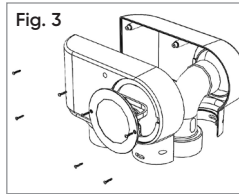

4) Once open, the locking tab on the 90D Reducer Elbow should disengage from the casing. Turn the elbow 180° on the 3" socket entrance (Figure 4) engaging the locking tab into the other side of the casing.

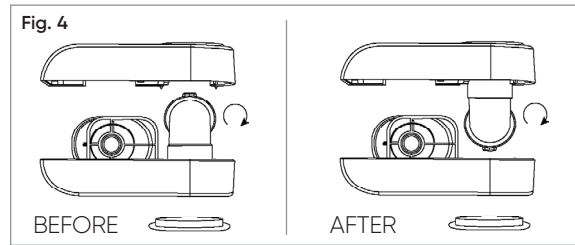

Gasket Inspection

5) Once engaged, close the casing again making sure to align the gap of the adjustable air vent assembly to sandwich the foam gasket to prevent peeling or damage. Inspect to make sure that the foam gasket remains intact (Figure 5) before re-installing the screws



Reverse the Access Panel and Pipe Socket Ring

6) Once fastened, the Access Panel and the Pipe Socket can be reinstalled using the screws on the opposite side (Figure 6).

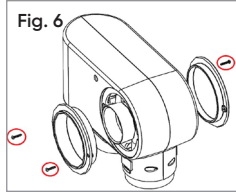

Vent Collar Spacing

7) The spacing between the appliance exhaust and air intake collars vary from appliance to appliance. Reference the appliance installation instructions to determine the center to center distance of the collars. If this information is not available, using a measuring tape measure from edge to edge to determine the collar vent spacing (D1) for the UCVK (Figure 7).



Adjust the Air Vent

8) Locate the adjustable air vent on the UCVK socket which seals on the foam gasket. Holding the UCVK unit securely, apply uniform force to the air vent down and away from the unit (Figure 8- Step 1) and shift it left or right (Figure 8- Step 2) until the spacing matches D1.

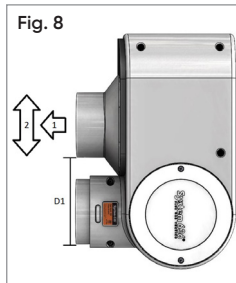

UNIVERSAL CONCENTRIC VENT KIT (UCVK™) (UL 1738 / ULC S636) INSTALLATION INSTRUCTIONS

System 1738
FLUE GAS VENTING

⚠ WARNING

Do NOT mix pipe, fittings, cements, or joining methods from different manufacturers, this can result in unsafe conditions and will void the certification and the product warranty.

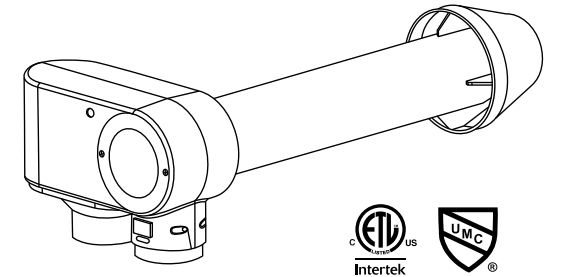

Refer to the appliance manufacturer's installation instructions to ensure that the Universal Concentric Vent Termination Kit (UCVK™) is permitted for use. The UCVK is fully certified for use with IPEX System 1738® and System 636®.

In the USA, this termination is for use with only System 1738 products unless mixing of components from different vent manufacturers is allowed by the authority having jurisdiction.

In Canada, the System 636 UCVK is for use with only System 636 product.

System 1738 PVC Universal Concentric Vent Kits are made from an engineered PVC compound certified to both UL 1738 and ULC S636 standards and are rated to a maximum temperature of 149°F (65°C).

All termination kits must be located and installed in accordance with the installation instructions found in this guide and with the local building code and NFPA 54 / ANSI Z223.1 National Fuel Gas Code.

These installation instructions are applicable to all System 1738® PVC UCVK™s.

WHAT'S IN THE BOX

Vent Retainer 	Concentric Pipe 	90D Reducer Elbow
Screw x 9 	Air Vent 	Clamshell Casing
Access Panel 	Pipe Socket 	Rain Cap

PRIOR TO INSTALLATION, PLEASE CONSIDER

1. Kits must be securely fastened to structure, to ensure clearance dimensions are maintained. Refer to the *System 1738® Installation Methods Guide** and local building codes for minimum installation clearances in different installation scenarios.
2. The weight of the UCVK™ must be supported by the clamps/straps and not by the vent system it connects to.
3. Insulating exhaust piping in unconditioned space to prevent freezing may be required by the local building code.
4. The pipe length of the UCVK can be shortened, provided that the cutting and welding procedures adhere to the System 1738 guidelines outlined in this guide.
5. Pipe lengths and/or fittings shall NOT be solvent welded to the exterior socket of the rain cap in order to divert or extend the exhaust gas, unless the appliance manufacture guidelines confirm that the extra length or the changing in direction will not adversely impact the flow of flue gas.
NOTE: THE PIPE LENGTH OF THE UCVK CANNOT BE LENGTHENED.
6. Ensure that the UCVK is configured to fit your venting system by following the instructions outlined with the Configuration guide on page 4.

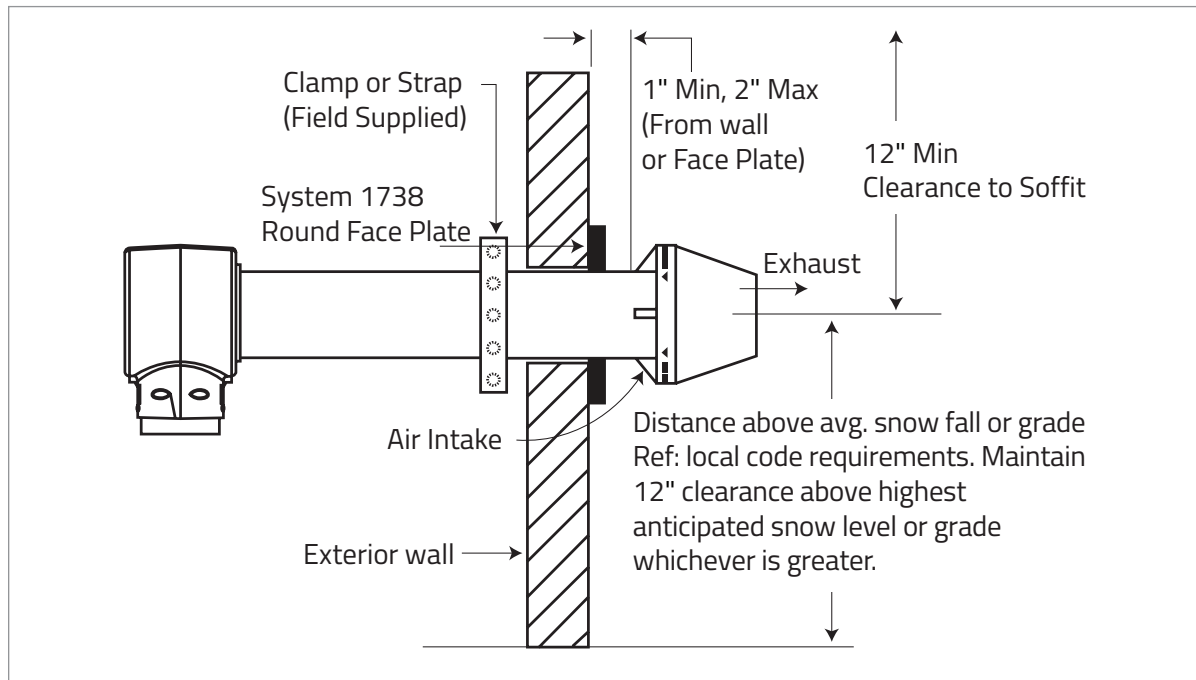

INSTALLATION PROCEDURES

1. Once the installer has determined the termination location, cut a 5 inch hole in the wall to provide a 1/4" on each side of the pipe.
2. As per the procedures outlined in the *System 1738® Installation Guide* (found at system1738.com), solvent weld the inner pipe to the internal 3" reducer elbow.
3. Solvent weld the outer pipe to the pipe socket.
4. Slide the concentric pipe assembly through the wall penetration (install flashing where needed)

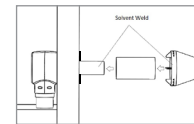
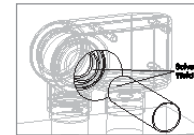
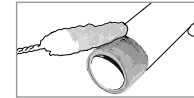

5. When required, solvent weld a 3" x 2" reducer bushing to both of the UCVK™ collars to accommodate a 2" venting system.

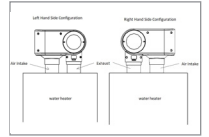

6. Once the rain cap is installed and the kit has been secured as outlined within the installation/support procedures, the kit can be connected to the venting system.

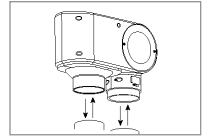

7. Pipe lengths to accommodate the connection at the termination height of the UCVK Unit are field supplied. Additional accessory components such as vent screens are sold separately.

SUPPORT PROCEDURES

1. The weight of the Universal Concentric Vent Kit (UCVK™) must be supported by the clamps/straps and not by the vent system it connects to.
2. Concentric pipe must be securely fastened to structure.
3. Straps are field supplied. Use straps, clamps or equivalent that will not score or damage the pipe. Expansion and contraction should be addressed between appliance and termination point.
4. All penetrations must be sealed according to local building codes. Caulking for side wall terminations are typical. Use only PVC/CPVC compatible sealing material, contact the sealant manufacturer for confirmation on compatibility with PVC.
5. The outer pipe shall be only a friction fit with the cap. To permanently affix the rain cap, apply solvent cement to the inner pipe as per the procedures outlined in the *System 1738 Installation Guide**.

For installations where removal of the cap may be required for service of the termination or cleaning the

cap, it can be fastened mechanically in accordance to the procedures outlined in the *System 1738 Installation Guide*.

