

Installation and Instruction Manual

NORITZ AMERICA
CORPORATION

GAS-FIRED DIRECT VENT BOILER

NH-2001-DV (Indoor Installation)
NH-1501-DV (Indoor Installation)

Potential dangers from accidents during installation and use are divided into the following three categories. Closely observe these warnings, they are critical to your safety.



DANGER

DANGER indicates an imminently hazardous situation which, if not avoided, will result in death or serious injury.



WARNING

WARNING indicates a potentially hazardous situation which, if not avoided, could result in death or serious injury.



CAUTION

CAUTION indicates a potentially hazardous situation which, if not avoided, may result in minor or moderate injury.

WARNING: If the information in this manual is not followed exactly, a fire or explosion may result causing property damage, personal injury or death.



Prohibited



Disconnect
Power



Ground



Be sure to do



CAUTION

Requests to Installers

- In order to use the boiler safely, read this installation and instruction manual carefully, and follow the installation instructions.
- Failures and damage caused by erroneous work or work not as instructed in this manual are not covered by the warranty.
- Check that the installation was done properly in accordance with this installation and instruction manual upon completion.
- After completing installation, please either place this installation and instruction manual in a plastic pouch and attach it to the side of the boiler or hand it to the customer. Also, be sure to fill in all of the required items on the warranty and to hand the warranty to the customer along with the User's information manual.

Installation must conform with local codes, or in the absence of local codes, the National Fuel Gas Code, ANSI Z223.1/NFPA 54- latest edition and/or CSA B149.1, Natural Gas and Propane Installation Code (NSCNGPIC).

Where required by the authority having jurisdiction, the installation must conform to the Standard for Controls and Safety Devices for Automatically Fired Boilers, ANSI/ASME CSD-1.

Noritz America reserves the right to discontinue, or change at any time, the designs and/or specifications of its products without notice.



Low NOx
Approved by
SCAQMD

Noritz America Corporation
11160 Grace Avenue,
Fountain Valley, CA 92708
www.noritz.com







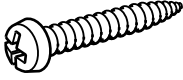
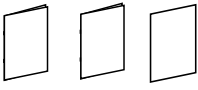

SAR8582 C

SAR8582-2
Rev. 09/07

1. Included Accessories

The following accessories are included with the boiler in the inside of package. Check for any missing items before starting installation.

Part	Shape	Q'ty	Part	Shape	Q'ty
Tapping Screw		5	User's Information Manual, Warranty, Installation and Instruction Manual (this document)		1 each
Safety Relief Valve		1	Safety Relief Valve Fitting and Gasket		1
Y terminal		4	Pressure & Temperature Gauge		1
Round terminal		11			

2. Optional Accessories

The accessories listed below are not included with the boilers, but may be necessary for installation.

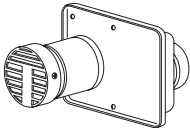
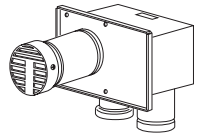
Part	Shape	Q'ty	Part	Shape	Q'ty
Flue Terminal VT4-TL		1	Flue Terminal VT4-TS		1

4. Choosing Installation Site

- * Locate the appliance in an area where leakage from the boiler or connections will not result in damage to the area adjacent to the appliance or to the lower floors of the structure. When such locations cannot be avoided, it is recommended that a suitable drain pan, adequately drained, be installed under the appliance. The pan must not restrict combustion air flow.
- * Install this boiler in a way that the constituent parts of the gas ignition system are protected from water (water drops, spray, rain, etc.) during device operation and repair (circulator replacement, drain trap or control device replacement, etc.).

DANGER

- Locate the vent terminal so that there are no obstacles around the termination and so that exhaust can't accumulate. Do not enclose the termination with corrugated metal or other materials.

WARNING

- The boiler is designed for indoor installation only. Never install it outdoors or in a bathroom, it may be damaged or a fire may be caused.
- Avoid places where fires are common, such as those where gasoline, benzene and adhesives are handled, or places in which corrosive gases (ammonia, chlorine, sulfur, ethylene compounds, acids) are present.
Using the incorrect voltage may result in fire or cracking.
- Avoid installation in places where special chemical agents (e.g., hair spray or spray detergent) are used.
Ignition failures and malfunction may occur as a result.
- Carbon Monoxide Poisoning Hazard. Do not install this boiler in a mobile home, recreation vehicle or on a boat.

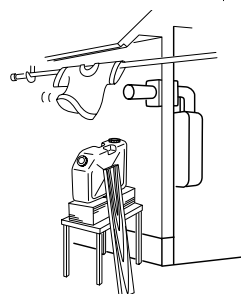
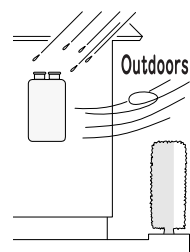

CAUTION

- Consult with the customer concerning the location of installation.
- Install the boiler in an area that allows for the proper clearances to combustible and noncombustible construction. Consult the rating plate on the appliance for proper clearances.
- Avoid installation in places where dust or debris will accumulate.
Dust may block the air-supply opening, causing the performance of the device fan to drop and incomplete combustion to occur as a result.
- Do not install the boiler in a place where it may be threatened by falling objects, such as under shelves.
- The boiler must be installed in a place where supply and exhaust pipes can be installed as directed.
- Do not install the boiler where the exhaust will blow on outer walls or material not resistant to heat. Also consider the surrounding trees and animals.
The heat and moisture from the boiler may cause discoloration of walls and resinous materials, or corrosion of aluminum materials.



CAUTION

- Avoid installation above gas ranges or stoves.
- Avoid installation between the kitchen fan and stove. If oily fumes or a large amount of steam are present in the installation location, take measures to prevent the fumes and steam from entering in the equipment.
- Install in a location where the exhaust gas flow will not be affected by fans or range hoods.
- Take care that noise and exhaust gas will not affect neighbors.
- Before installing, make sure that the exhaust flue termination will have the proper clearances according to the National Fuel Gas Code (ANSI Z223.1).
- Installation must conform with local codes, or in the absence of local codes, the National Fuel Gas Code, ANSI Z223.1/ NFPA 54- latest edition and/or CSA B149.1, Natural Gas and Propane Installation Code (NSCNGPIC).



Prohibited

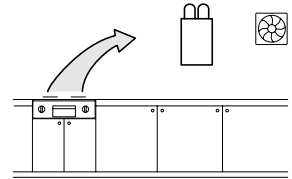

Be sure to do

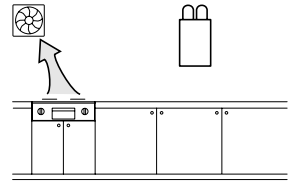

Prohibited

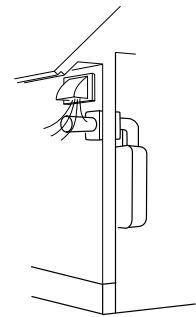

State of California: The boiler must be braced, anchored or strapped to avoid moving during an earthquake. Contact local utilities for code requirements in your area or call: 1-866-766-7489 and request instructions.

For Venting Manufacturers Requirements, see websites or phone numbers listed below:

Noritz N-Vent	www.noritz.com
Protech FastNSeal & W2	www.protechinfo.com
HeatFab SafTVent	www.heat-fab.com
Z-Flex Z-Vent	www.z-flex.com
Flex-L StaR-34	1-800-561-1980

5. Installation Clearances

WARNING

Before installing, check for the following:

Install in accordance with relevant building and mechanical codes, as well as any local, state or national regulations, or in the absence of local and state codes, to the National Fuel Gas Code ANSI Z223.1/NFPA 54 – latest edition. In Canada, see NSCPGIC for detailed requirements.

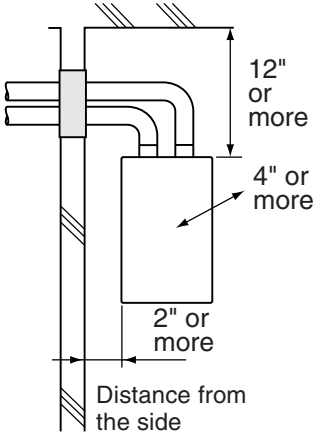
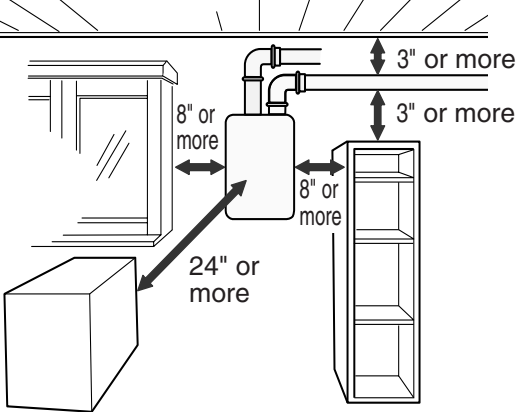
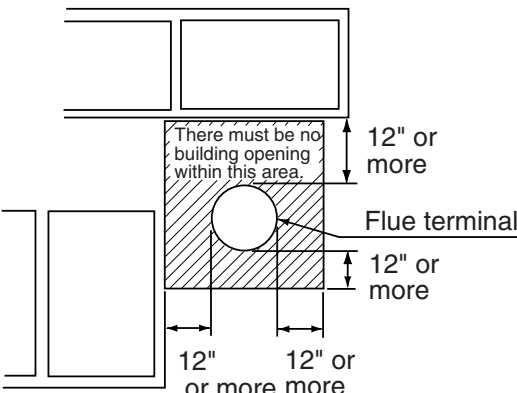
Item	Check	Illustration
Distance from combustibles	<ul style="list-style-type: none"> Maintain the following clearances from both combustible and non-combustible materials. 	
Securing of space for repair/inspection	<ul style="list-style-type: none"> If possible, leave 8" or more on either side of the unit to facilitate inspection. If possible, leave 24" or more in front of the unit to facilitate maintenance and service if necessary. If possible, leave 3" or more above and below the vent pipe to facilitate inspection and repair if necessary 	
Outdoor Clearances to Opening into Any Building	<ul style="list-style-type: none"> There must be a clearance of 24" or more in front of the Flue terminal. This restriction will not be applied to an area where an effective shield makes a clearance of 24" or more in front of the exhaust outlet. 	

Clearance Requirements from Vent Terminations to Building Openings

* All clearance requirements are in accordance with ANSI Z21.13 and the National Fuel Gas Code, ANSI Z223.1 and in Canada, in accordance with NSCNPIC.

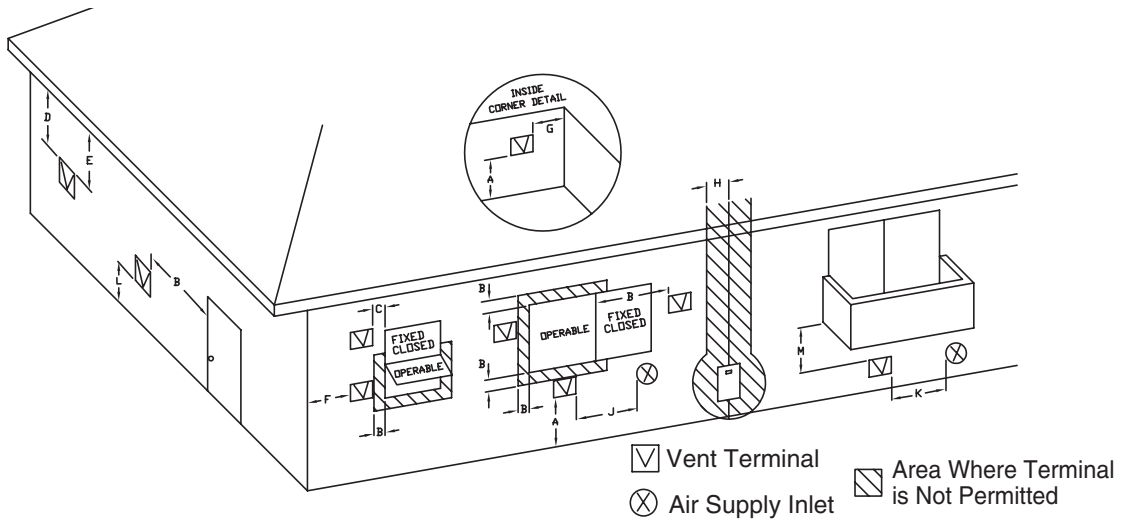

	Clearance	
A=	Above grade, veranda, porch, deck, or balcony	12" (12")
B=	Window or door that may be opened	12" (36")
C=	Permanently closed window	*
D=	Vertical clearance to ventilated soffit located above the terminal within a horizontal distance of 2 feet from the center of the terminal	*
E=	Unventilated soffit	*
F=	Outside corner	*
G=	Inside corner	*
H=	Each side of center line extended above meter/regulator assembly	3' within a height 15' above meter/regulator assembly
I=	Service regulator vent outlet	3'
J=	Nonmechanical air supply inlet or combustion air inlet to any other appliance	12" (36")
K=	Mechanical air supply inlet	3' above if within 10' (6')
L=	Above paved sidewalk or paved driveway located on public property	(7' ***)
M=	Under veranda, porch, deck, or balcony	* (12"- Canada Only****)

()= indicates clearances required in Canada

*Maintain clearances in accordance with local installation codes and the requirements of the gas supplier

***A vent shall not terminate directly above a sidewalk or paved driveway that is located between two single family dwellings and serves both dwellings.

****Permitted only if veranda, porch, deck, or balcony is fully open on a minimum of two sides beneath the floor.

6. Installation

Securing to the wall



Be sure to do

- The weight of the device will be applied to the wall. If the strength of the wall is not sufficient, reinforcement must be done to prevent the transfer of vibration.
- Do not drop or apply unnecessary force to the device when installing. Internal parts may be damaged and may become highly dangerous.
- Install the boiler on a vertical wall and ensure that it is level.

Item	Check	Illustration
Locating Screw Holes	<div style="border: 2px solid black; padding: 10px; margin-bottom: 10px;"> CAUTION </div> <ul style="list-style-type: none"> • When installing with bare hands, take caution to not inflict injury. • Be careful not to hit electrical wiring, gas, or water piping while drilling holes. <ol style="list-style-type: none"> 1. Drill a single screw hole, making sure to hit a stud. 2. Insert and tighten the screw and hang the boiler by the upper wall mounting bracket. 3. Determine the positions for the remaining four screws (two for the top bracket and two for the bottom), and remove the boiler. 	<p style="text-align: center;">Location of Screw Hole</p>
Mounting	<ol style="list-style-type: none"> 4. Drill holes for the remaining four screws. 5. Hang the boiler again by the first screw, and then insert and tighten the remaining four screws. 6. Take waterproofing measures so that water does not enter the building from screws mounting the device. 	<p style="text-align: center;">Tapping Screw</p>
Structure	<ul style="list-style-type: none"> • Make sure the boiler is installed securely so that it will not fall or move due to vibrations or earthquakes. 	
Installations at Elevations Above 2,000 ft.	<ul style="list-style-type: none"> • If this boiler is being installed at an elevation of 2,000 ft. (610m) or higher, disconnect the connector labeled "High Elevation Disconnect" as illustrated on the right. This connector is located inside the unit. • Disconnect power to the boiler before disconnecting this connector. Failure to perform this step will result in a "733" code displayed on the boiler control panel and a cease in operation. If this occurs, disconnect, then reconnect power to the boiler to reset the system. 	

7. Vent Pipe Installation

Vent Terminal Installation

- Follow the installation instructions included with the vent terminal. It is suggested that the appliance be vented horizontally through a sidewall. If a vertical vent termination is required, it must follow the requirements of this section (p.9-12).

Vent Terminal Installation Precautions

Note the following vent terminal installation requirements

- Do not install the vent terminal indoors

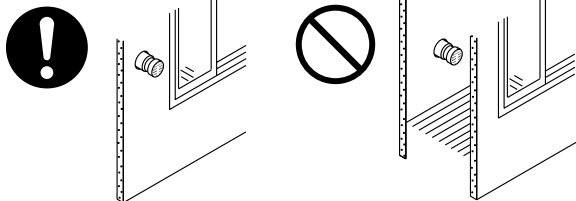

- Install the vent terminal with a downward slope

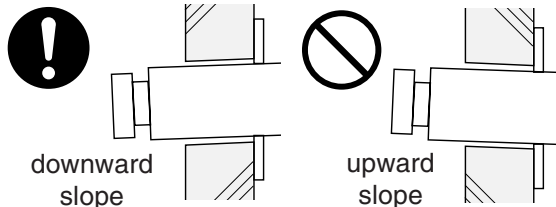

- Install with the proper length protruding through the wall

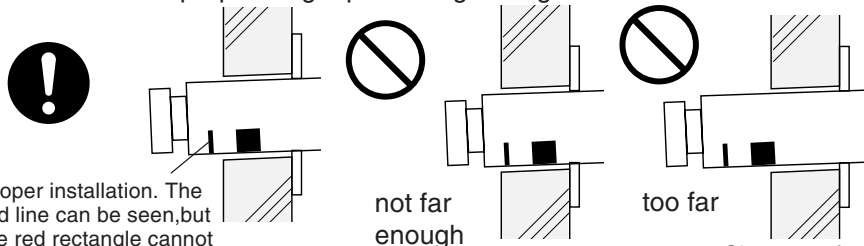

- Avoid storing hazardous objects near the terminal

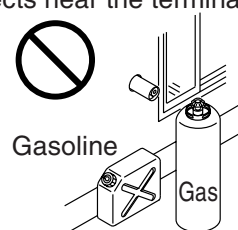

Proper installation. The red line can be seen, but the red rectangle cannot be seen from the outside.

- Avoid installing the terminal where obstacles will block it

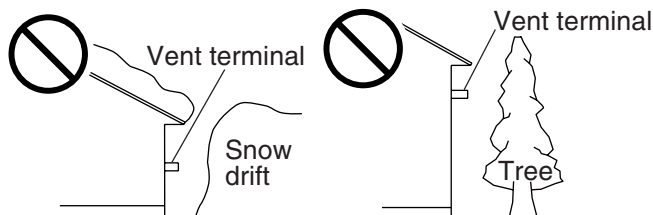

- Clearance from vent terminal. If multiple boilers are installed, terminals must be separated by 12" or more in a plain view regardless of the vertical clearance.

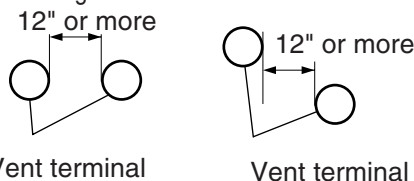

- Do not install the vent terminals vertically in-line. Do not cover the vent terminal with any type of protective screen or enclosure. In-line or blocked terminals can cause abnormal combustion resulting in undesired performance from the boiler.

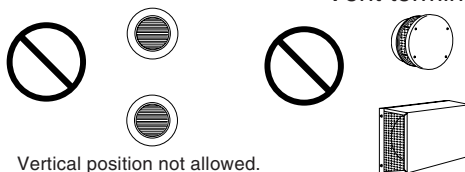

Vent terminal models

- Use only the following models of Noritz vent terminals with this boiler.

Vent terminal	• VT4-TL (for long vent runs)
	• VT4-TS (to be installed directly on top of the appliance)

- Vent terminal size variations are listed in the table below. Choose the model according to the wall thickness required.

Model	Wall thickness (in.)
VT4-TL-5	3.5" to 5.1"
VT4-TL-8	5.1" to 8.3"
VT4-TL-14	8.3" to 14.6"
VT4-TL-27	14.6" to 27.2"

Vent system installation example

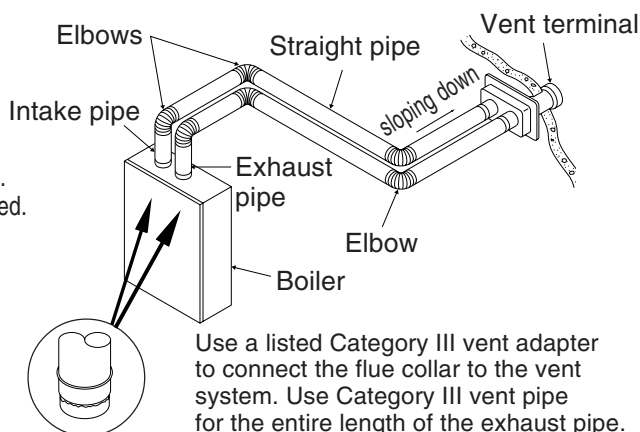



WARNING



Be sure to do

CARBON MONOXIDE POISONING

Follow all vent system requirements in accordance with relevant local or state regulation, or, in the absence of local or state code, in the U.S. to the National Fuel Gas Code ANSI Z233.1/NFPA 54 – latest edition, and in Canada, in accordance with NSCNPIC.

Venting Precautions

- Use 4" diameter Category III vent pipe.
- Maximum vent length

Number of 90 degree elbows	Maximum Vent Length
4	39'
3	45'
2	51'
1	57'

- Exceeding the maximum vent length is dangerous and may result in bad combustion.
- If possible, don't install the vent pipe through any enclosed areas. If necessary, consult the pipe manufacturer's instructions for clearances.
- Install the vent terminal so that all exhaust is directed to and all intake air is taken from outdoors.
- In the Commonwealth of Massachusetts a carbon monoxide detector is required for all side wall horizontally vented gas fuel equipment. Please refer to Technical Bulletin TB 010606 for full installation instructions.

- Do not store hazardous or flammable substances near the vent terminal .
- Slope the intake and exhaust pipes downwards 1/4" for every 12" towards the termination.
- Use only UL listed Category III venting products.
- Connect the vent pipe firmly so that it will prevent exhaust gases from leaking.
- Steam or condensed water may drip out of the vent terminal. Dispose of this condensed water according to local codes and in order to prevent injury or property damage.
- If this product will be installed in an area where snow is known to accumulate, protect the vent termination from blockage by snow drifts or damage from snow falling off of roofs.
- Support the vent pipe with hangers at intervals as required by the vent pipe manufacturer's installation instructions.
- Install the vent terminal so that it is easily accessible for maintenance both from the indoors and the outdoors.
- If the vent terminal will be installed higher than the boiler, make the vertical section directly above the boiler as short as possible, and slope down to the terminal. Do not have another vertical section after the horizontal section begins.
- Make the vertical pipe as short as possible.

- Follow the vent pipe manufacturer's installation instructions.
- Maintain the same vent pipe diameter all the way to the end.
- Maintain the following clearances for the exhaust pipe to combustibles:

Manufacturer and Product	Enclosed		Unenclosed	
	Hor.	Vert.	Hor.	Vert.
Noritz N-Vent	10" (sides) 15" (top) 6" (bottom)	4"	1"	1"
Protech FasNSeal	8" (sides) 12" (top) 4" (bottom)	4"	3"	3"
Protech FasNSeal W2	6"	4"	3"	3"
HeatFab SafTVent	6"	6"	2"	2"
Z-Flex Z-Vent	8"	4"	1"	1"
Flex-L-StaR-34	8"	4"	1"	1"

These clearances are subject to change. Refer to the UL listing for the proper clearances.

- Do not common vent or connect more than one appliance to this venting system.

Appliance Adapters

- Use the following adapters to connect the boiler to the venting system.

Manufacturer and Product	Part No.
Protech FasNSeal	FSAA4
HeatFab SafTVent	9401RYPK
Z-Flex Z-Vent	2SVWA04
Flex-L StaR-34	SRASPSA4

- Terminate at least 12" above grade or snow line
- Terminate at least 7' above a public walkway
- Use a condensation drain if necessary



DANGER

The boiler is not intended to be common vented with any other existing appliance!

Boiler removal from a common vent system

At the time of removal of an existing heater, the following steps shall be followed with each appliance remaining connected to the common venting system placed in operation, while the other appliances remaining connected to common venting system are not operating.

1. Seal any unused openings in the common venting system.
2. Visually inspect the venting system for proper size and horizontal pitch to determine if there is blockage, leakage, corrosion or other deficiencies that could cause an unsafe condition.
3. If practical, close all building doors, windows and all doors between the space in which the appliance remains connected to the common venting system located and other spaces in the building. Turn on clothes dryers and any appliances not connected to the common venting system. Turn on any exhaust fans, such as range hoods and bathroom exhausts, at maximum speed. Do not operate a summer exhaust fan. Close all fireplace dampers.
4. Place in operation the appliance being inspected. Follow the lighting instructions. Adjust the thermostat so the appliance will operate continuously.
5. Test for spillage at the draft hood relief opening after 5 minutes of main burner operation. Use the flame of a match or candle or smoke from a cigarette.
6. After it has been determined that each appliance remaining connected to common venting system properly vents when tested as outlined, return doors, windows, exhaust fans, fireplace dampers and any other gas burning appliance to their previous condition of use.
7. Any improper operation of the common venting system should be corrected so the installation conforms with the National Fuel Gas Code, ANSI Z223.1/NFPA 54 and/or CAN/CSA B149.1, Natural Gas and Propane Installation Code. When resizing any portion of the common venting system, the common venting system should be resized to approach the minimum size as determined using the appropriate tables in Part 11 of the National Fuel Gas Code ANSI Z223.1/NFPA 54 and/or CAN/CSA B149.1 Natural Gas and Propane Installation Code.

Vertical Vent Termination

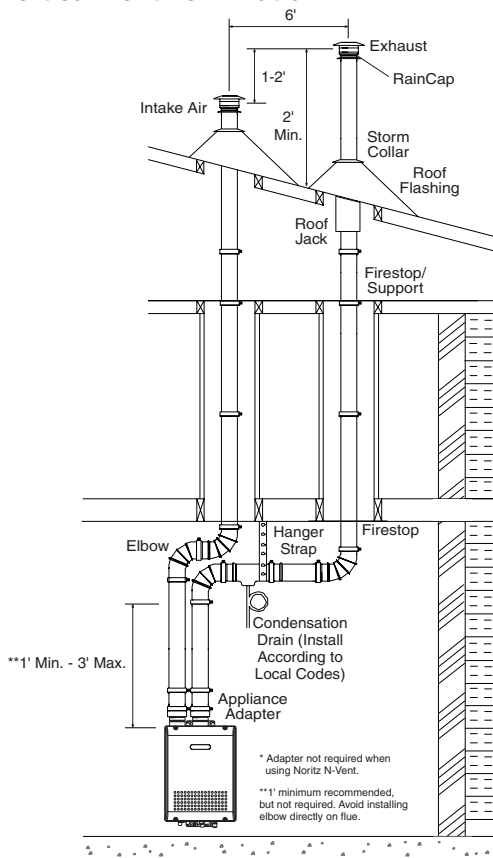

- Terminate at least 6' from the combustion air intake of any appliance, and 3' from any other building opening, gas utility meter, service regulator etc.
- Enclose exterior vent systems below the roof line to limit condensation and protect against mechanical failure.
- When the vent penetrates a floor or ceiling and is not running in a fire rated shaft, a firestop and support is required.
- Terminate the vent system at least 2' above, but not more than 6' above the roof line, or according to the vent pipe manufacturer's instructions.
- Provide vertical support every 12' or as required by the vent pipe manufacturer's instructions.
- Slope the horizontal vent 1/4" downwards for every 12".
- Do not vent straight upwards. Always have a horizontal section of venting.
- Install a condensation drain in the horizontal section of the venting.

When the intake/exhaust pipes pass through an enclosed space:

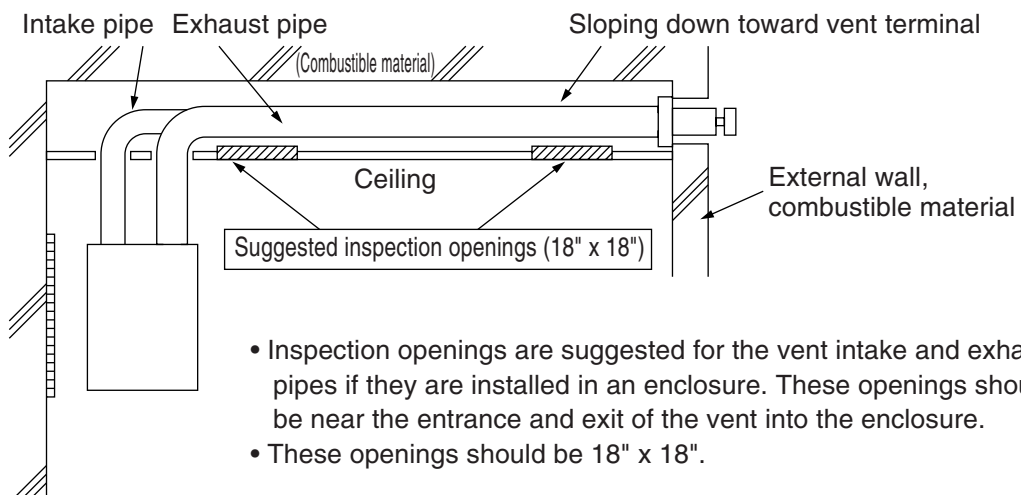

- Inspection openings are suggested for the vent intake and exhaust pipes if they are installed in an enclosure. These openings should be near the entrance and exit of the vent into the enclosure.
- These openings should be 18" x 18".

8. Gas Piping

Follow the instructions from the gas supplier.

The appliance and its individual shutoff valve must be disconnected from the gas supply piping system during any pressure testing of that system at test pressures in excess of 1/2 psi (3.5 kPa).

The Appliance must be isolated from the gas supply piping system by closing its individual manual shutoff valve during any pressure testing of the gas supply piping system at test pressures equal to or less than 1/2 psi (3.5 kPa).

The appliance and its gas connections must be leak tested before placing the appliance in operation.

The inlet gas pressure must be within the range specified. This is for the purposes of input adjustment.

In order to choose the proper size for the gas line, Installation must conform with local codes, or in the absence of local codes, the National Fuel Gas Code, ANSI Z223.1/NFPA 54- latest edition and/or CSA B149.1, Natural Gas and Propane Installation Code (NSCNGPIC).

A sediment trap must be installed upstream of the gas controls. The sediment trap can be installed as illustrated to the right or as allowed by applicable codes.

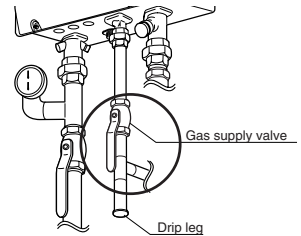

Gas Pressure

Size the gas line according to total btuh demand of the building and length from the meter or regulator so that the following supply pressures are available even at maximum demand:

Natural Gas Supply Pressure

Min. 4" WC
Max. 10.5" WC

LP Gas Supply Pressure

Min. 8" WC
Max. 14" WC

Gas Meter

Select a gas meter capable of supplying the entire btuh demand of all gas appliances in the building.

Gas Connection

- Do not use piping with a diameter smaller than the inlet diameter of the boiler.
- Flexible gas pipes not conforming to NH-2001 (199,900 Btuh) or NH-1501 (150,000 Btuh) standards are not recommended.
- Install a gas shutoff valve on the supply line.
- Use only approved gas piping materials.

Measuring Gas Pressure

[Primary gas pressure]

In order to check the gas supply pressure to the unit, a tap is provided on the gas inlet. Remove the hex head philips screw from the tap, and connect a manometer using a silicon tube. (Right figure)

[Manifold pressure]

In order to check the gas manifold pressure, tap is are provided on the gas valve inside the unit. The pressure can be checked either by removing the hex head philips screw and connecting a manometer with a silicon tube, or by removing the 1/8" NPT screw with an allen wrench and connecting the appropriate pressure gauge.

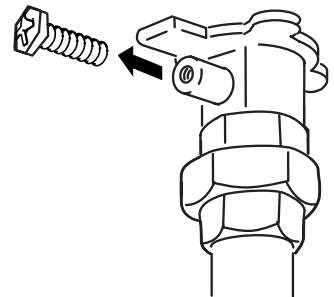

Sample Gas Line

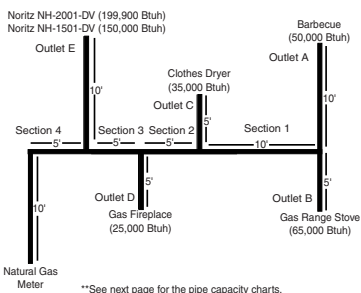

Instructions

- Size each outlet branch starting from the furthest using the Btuh required and the length from the meter.
- Size each section of the main line using the length to the furthest outlet and the Btuh required by everything after that section.

Sample Calculation

- Outlet A: 45' (Use 50'), 50,000 Btuh requires 1/2"
 Outlet B: 40', 65,000 Btuh requires 1/2"
 Section 1: 45' (Use 50'), 115,000 Btuh requires 3/4"
 Outlet C: 30', 35,000 Btuh requires 1/2"
 Section 2: 45' (Use 50'), 150,000 Btuh requires 3/4"
 Outlet D: 25' (Use 30'), 25,000 Btuh requires 1/2"
 Section 3: 45' (Use 50'), 175,000 Btuh requires 1"
 Outlet E: 25' (Use 30'), NH-2001-DV (199,900 Btuh) requires 3/4",
 NH-1501-DV (150,000 Btuh) requires 3/4",
 Section 4: 45' (Use 50'), NH-2001-DV (374,900 Btuh) requires 1-1/4",
 NH-1501-DV (325,000 Btuh) requires 1-1/4".

Gas Line Sizing Charts

Adapted from UPC 1997

Maximum **Natural Gas** Delivery Capacity in Cubic Feet per Hour (0.60 Specific Gravity, 0.5" WC Pressure Drop)

Pipe Size	Length in Feet										
	10'	20'	30'	40'	50'	60'	70'	80'	90'	100'	125'
1/2"	174	119	96	82	73	66	61	56	53	50	44
3/4"	363	249	200	171	152	138	127	118	111	104	93
1"	684	470	377	323	286	259	239	222	208	197	174
1 1/4"	1404	965	775	663	588	532	490	456	428	404	358
1 1/2"	2103	1445	1161	993	880	798	734	683	641	605	536
2"	4050	2784	2235	1913	1696	1536	1413	1315	1234	1165	1033
2 1/2"	6455	4437	3563	3049	2703	2449	2253	2096	1966	1857	1646
3"	11,412	7843	6299	5391	4778	4329	3983	3705	3476	3284	2910
3 1/2"	16,709	11,484	9222	7893	6995	6338	5831	5425	5090	4808	4261
4"	23,277	15,998	12,847	10,995	9745	8830	8123	7557	7091	6698	5936

Contact the Gas Supplier for Btu/Cubic Ft. of the Supplied Gas. 1000 BTU/Cubic Ft. is a Typical Value

Maximum **Liquified Petroleum** (Undiluted) Delivery Capacity in Thousands of Btuh (0.5" WC Pressure Drop)

Pipe Size	Length in Feet												
	10'	20'	30'	40'	50'	60'	70'	80'	90'	100'	125'	150'	200'
1/2"	275	189	152	129	114	103	96	89	83	78	69	63	55
3/4"	567	393	315	267	237	217	196	185	173	162	146	132	112
1"	1071	732	590	504	448	409	378	346	322	307	275	252	213
1 1/4"	2205	1496	1212	1039	913	834	771	724	677	630	567	511	440
1 1/2"	3307	2299	1858	1559	1417	1275	1181	1086	1023	976	866	787	675
2"	6221	4331	3465	2992	2646	2394	2205	2047	1921	1811	1606	1496	1260

** For reference only. Please consult gas pipe manufacturer for actual pipe capacities.

Maximum Capacity of Flex TracPipe® in Cubic Feet per Hour of **Natural Gas** (0.60 Specific Gravity, 0.5" WC Pressure Drop)

Pipe Size	Length in Feet											
	10'	20'	30'	40'	50'	60'	70'	80'	90'	100'	150'	200'
3/4"	206	147	121	105	94	86	80	75	71	67	55	48
1"	383	269	218	188	168	153	141	132	125	118	94	82
1 1/4"	614	418	334	284	251	227	209	194	181	171	137	116
1 1/2"	1261	888	723	625	559	509	471	440	415	393	320	277
2"	2934	2078	1698	1472	1317	1203	1114	1042	983	933	762	661

Maximum Capacity of Flex TracPipe® in Thousands of Btuh **Liquified Petroleum** (0.5" WC Pressure Drop)

Pipe Size	Length in Feet											
	10'	20'	30'	40'	50'	60'	70'	80'	90'	100'	150'	200'
3/4"	325	232	191	166	149	136	126	118	112	106	87	76
1"	605	425	344	297	265	241	222	208	197	186	143	129
1 1/4"	971	661	528	449	397	359	330	307	286	270	217	183
1 1/2"	1993	1404	1143	988	884	805	745	696	656	621	506	438
2"	4638	3285	2684	2327	2082	1902	1761	1647	1554	1475	1205	1045

** For reference only. Please consult gas pipe manufacturer for actual pipe capacities.

TracPipe® is a registered trademark of Omega Flex.

Maximum Capacity for Gas Flex Connectors in Cubic Feet per Hour of **Natural Gas** (0.60 Specific Gravity, 0.5" WC Pressure Drop)

Pipe Size	Length in Inches					
	12"	24"	36"	48"	60"	72"
1/2"	180	150	125	106	93	86
3/4"	—	290	255	215	197	173
1"	—	581	512	442	397	347
1 1/4"	—	1470	1200	1130	960	930

Maximum Capacity for Gas Flex Connectors in Thousands of Btuh **Liquified Petroleum** (0.5" WC Pressure Drop)

Pipe Size	Length in Inches					
	12"	24"	36"	48"	60"	72"
1/2"	288	240	200	169	149	137
3/4"	—	465	409	344	315	278
1"	—	930	825	708	638	556
1 1/4"	—	2352	1920	1808	1536	1488

** For reference only. Please consult gas pipe manufacturer for actual pipe capacities.

9. Water Piping

Installation and service must be performed by a qualified plumber. In the Commonwealth of Massachusetts, this product must be installed by a licensed plumber or gas fitter in accordance with the Massachusetts Plumbing and Fuel Gas Code 248 CMR Sections 2.00 and 5.00. Observe all applicable codes.

This appliance suitable for space heating applications. Do not use this appliance if any part has been underwater. Immediately call a qualified service technician to inspect the appliance and replace any part of the control system and gas control which has been under water.

A relief valve that is rated in accordance with and complying with The ANSI/ASME Boiler and Pressure Vessel Code, Section IV (Heating Boilers) must be installed on the left side of the case. A pressure relief valve, fitting, and gasket is provided with this boiler and should be installed as shown below. This pressure relief valve must have the hourly rated temperature discharge capacity (199,900 Btuh for the NH-2001-DV, 150,000 Btuh for the NH-1501-DV). The relief capacity must not exceed 30 psi. No valve shall be placed between the relief valve and the boiler. The relief valve must be installed such that the discharge will be conducted to a suitable place for disposal when relief occurs. No reducing coupling or other restriction may be installed in the discharge line. The discharge line must be installed to allow complete drainage of both the valve and the line. If this unit is installed with a separate storage vessel, the separate vessel must have its own temperature and pressure relief valve. This valve must also comply with The Standard for Relief Valves and Automatic Gas Shutoff Devices for Hot Water Supply Systems, ANSI Z21.22. (in the U.S. only). A temperature relief valve is not required, but if one is used, do not install the valve with the probe directly in the flow of water. This may cause unwarranted discharge of the valve.

Toxic chemicals, such as those used for boiler treatment, shall not be introduced into the potable water.

- Flush water through the pipe to clean out metal powder, sand and dirt before connecting it.
- Take appropriate heat insulation measures (e.g., wrapping with heat insulation materials, using electric heaters) according to the climate of the region to prevent the pipe from freezing.
- Use a union coupling or flexible pipe for connecting the pipes to reduce the force applied to the piping.
- Avoid using joints as much as possible to keep the piping simple.
- Avoid piping in which an air holdup can occur.
- Be sure to used approved piping materials.

Water piping

- When using plastic pipe, use pipe with an oxygen diffusion barrier which is manufactured to DIN4726.
- The longer the piping, the greater the heat loss. Try to make the piping as short as possible.

System Sizing

- For optimal operation, design the piping and size the pump to flow a minimum of 4.0 GPM.

The boiler ,when used in connection with a refrigeration system, must be installed so the chilled medium is piped in parallel with the boiler with appropriate valves to prevent the the chilled medium from entering the boiler.

The boiler piping system of a hot water boiler connected to heating coils located in air handling units where they may be exposed to refrigerated air circulation must be equipped with flow control valves or other automatic means to prevent gravity circulation of the boiler water during the cooling cycle.

10. Relief Valve Mounting

Before installing the relief valve, test the piping at 45 psi with the cap on.

1. Remove the front cover of the unit.
2. Remove the single screw holding the cap to the housing.
 - Do not lose this screw, it will be used in a later step.

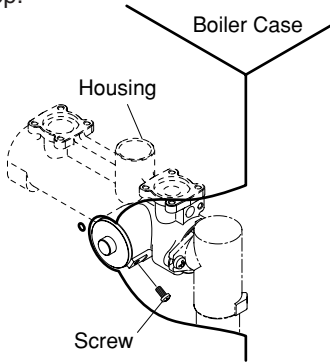

3. Remove the cap.

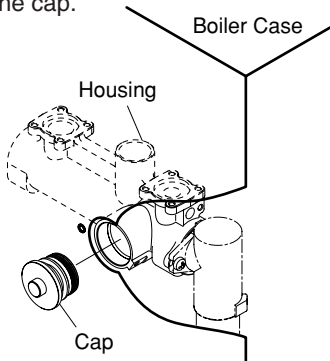

4. Locate the gasket supplied with the boiler, remove the paper backing, and attach it to the supplied fitting around the flange.

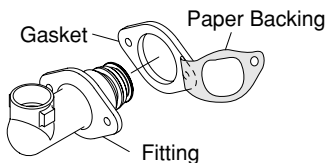

5. Install the relief valve (supplied separately) in the fitting before attaching it to the boiler.

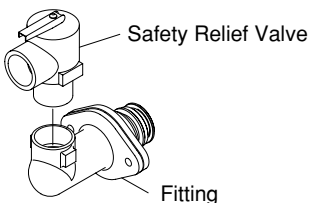

6. Insert the relief valve assembly into the housing being careful not to damage the o-ring. Insert and tighten the screw that was previously removed in step 2.

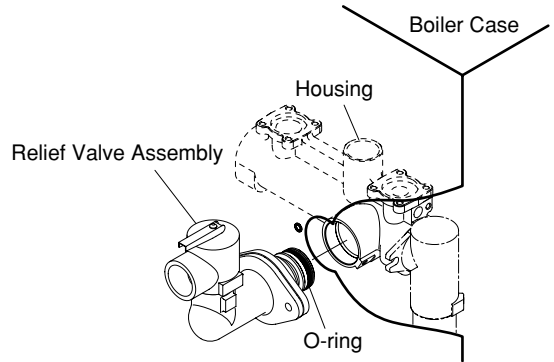

Press the fitting firmly into the housing while tightening the screw. Failure to do so could cause a leak.

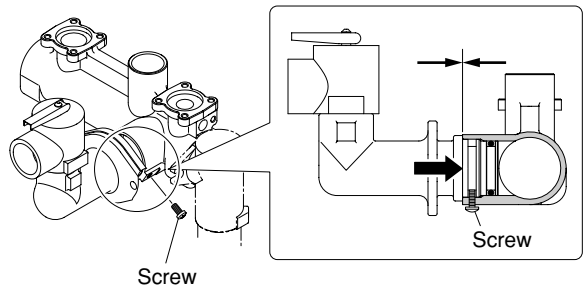

7. Secure the relief valve assembly to the boiler case with the 2 supplied screws.

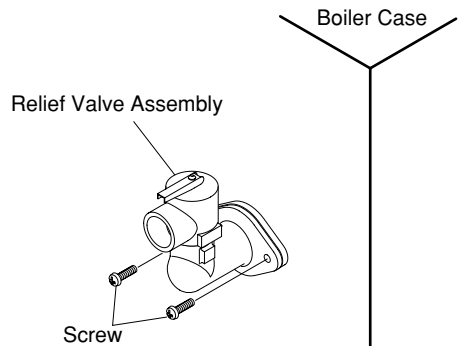

8. Replace the front cover of the unit.

NOTE

When attaching the drain line to the end of the relief valve, do not apply excess force to the end of the relief valve assembly. Excessive force can damage both the casing and the internal piping.

11. Plumbing Applications

The boiler piping system of a hot water boiler connected to heating coils located in air handling units where they may be exposed to refrigerated air circulation must be equipped with flow control valves or other automatic means to prevent gravity circulation of the boiler water during the cooling cycle.

- Before operating for the first time, confirm that 2.5 GPM flows through with only the bypass circuit opened (with the heating and indirect domestic hot water loops closed).

* This flow rate can be confirmed by adjusting the gate valve on the bypass circuit until the controller indicates that the unit is heating.

- Do not install air separators where negative pressure can develop in the system. Air will be drawn in. Install air separators at the highest level in the system

- Inspect expansion tanks once a year to confirm there is enough air in them.

- Replace anti freeze every two years to prevent corrosion and clogging of the pipes.

- Test the pressure relief valve once a year to ensure it works properly.

- This unit is designed so that the indirect water heating loop will have priority over the hydronic heating loop, so design the system so that the air handler will shut down if it is not receiving hot water.

- This product is designed with a water flow switch, so no LWCO is necessary. If local codes require a LWCO, install it on the power supply line. Refer to the installation and instruction manual of the LWCO for details.

- There is a filter on the return into the unit. Clean this after installation and again during inspection.

- This product was shipped with a cap where the relief valve should be installed. After installation, test the piping at 45 psi with the cap on, and then install the relief valve afterwards.

Pump Cautions

- Use the circulating pumps listed below or their equivalents. Add a pump if these are too small. The pump terminal in the unit is rated for 2.2 Amps. (See p.25 for instructions for pumps that require greater than 2.2 Amps).

Taco Model 0013:F3 (1/6 HP) Grundfos Model 26-99F (1/6 HP)

Size the circulating pump based on the pressure loss of the boiler and the piping.

- Install the circulating pump near the return to the boiler.

Electrical Cautions

- Connect the power to the circulating pumps to the terminal in the boiler.

- This model does not require a boiler protection loop.

- The unit may operate under cold weather conditions to prevent freezing.

- The freeze protection in this appliance relies on the ability to control the water that is circulating through it. In order to be protected from cold weather, please make sure that nothing will prevent the unit from being able to circulate water:

- The freeze prevention in this appliance will not work if power is lost or disconnected, if power is not connected to the pump, if the pump is not connected to the unit, or if the pump fails.

- Additionally, if any of the loops that the boiler is supplying hot water to is blocked or shut off, the freeze prevention may not be able to function properly.

- Connect the pump on the indirect water heating loop to the discharge side of the pump for the heating loop (See diagram)

- Use an aquastat on the indirect domestic water heating tank and connect it to the Priority 1 terminal inside the boiler. Connect the thermostat of the heating system to the Priority 2 terminal in the boiler.

- A 15 VDC, 0.1 Amp signal flows in the terminals. Use low Amp thermostats or zone controllers. 15 Amp devices may not operate properly.

HYDRONIC HEATING WITH INDIRECT DOMESTIC HOT WATER (SINGLE PUMP PER SYSTEM)

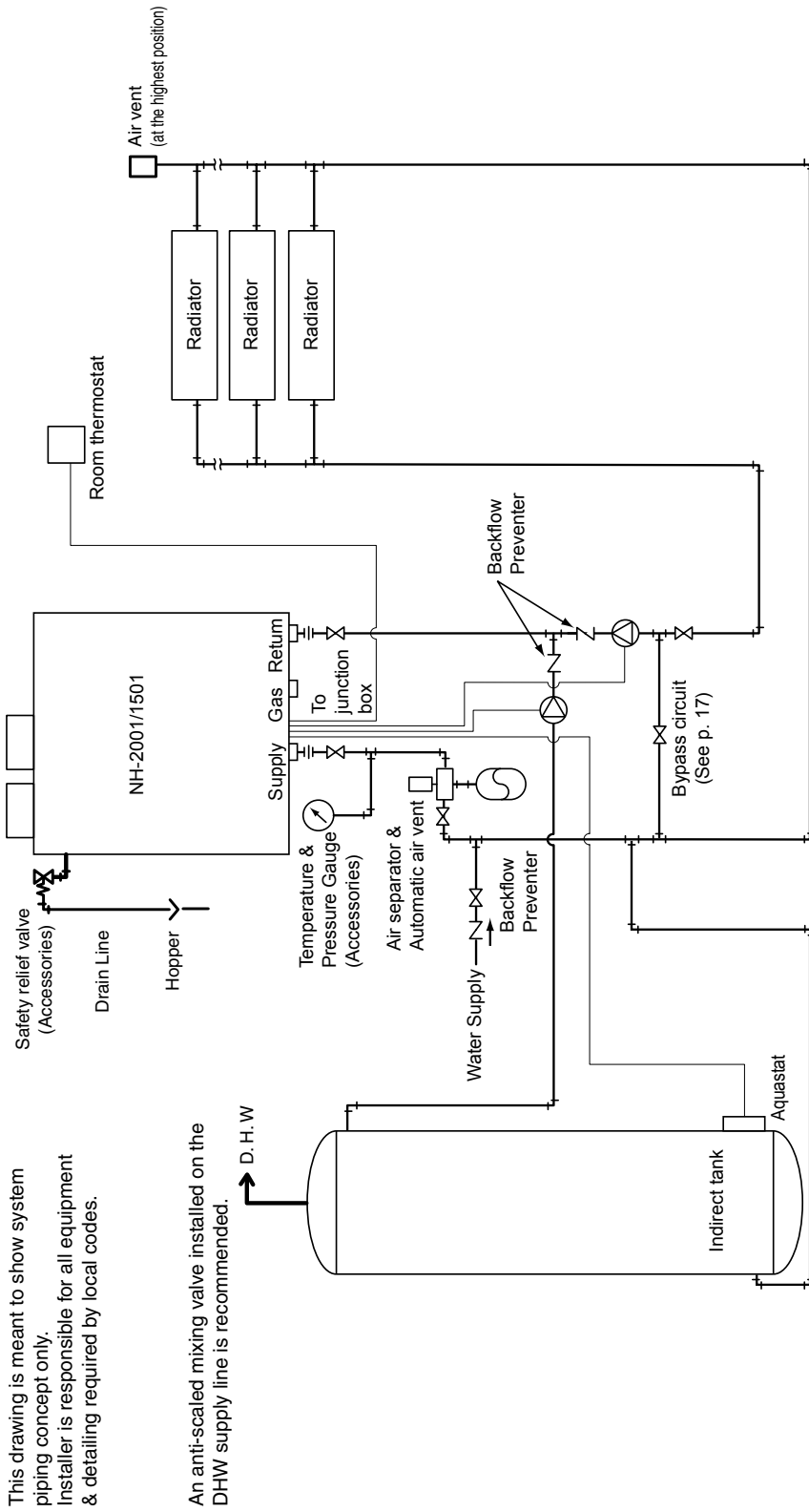

HYDRONIC HEATING WITH INDIRECT DOMESTIC HOT WATER (ADDITIONAL PUMP REQUIRED ON HEATING LOOP)

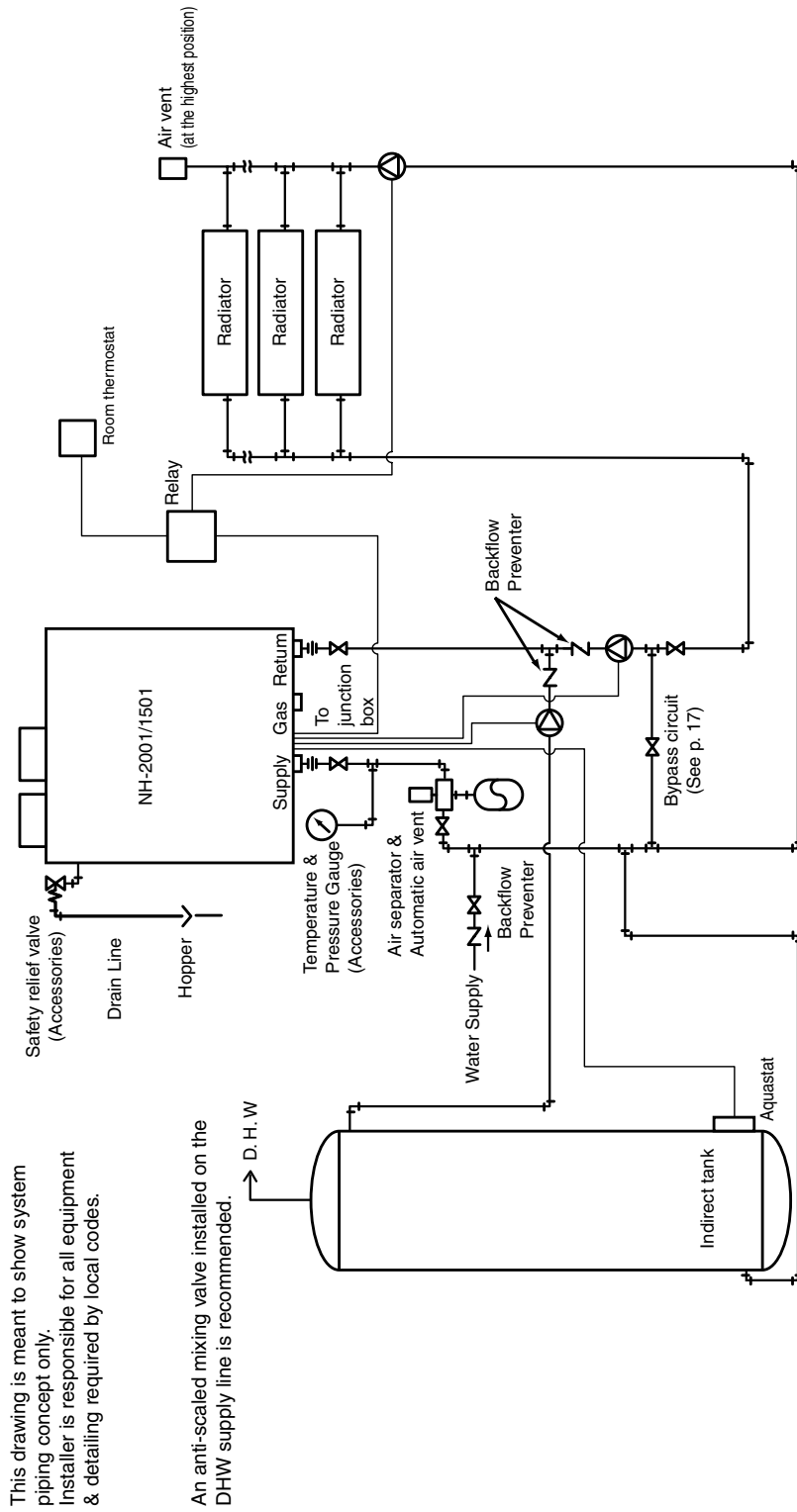

This drawing is meant to show system piping concept only. Installer is responsible for all equipment & detailing required by local codes.

An anti-scaled mixing valve installed on the DHW supply line is recommended.

HYDRONIC HEATING WITH ZONE CONTROLLER AND INDIRECT DOMESTIC HOT WATER

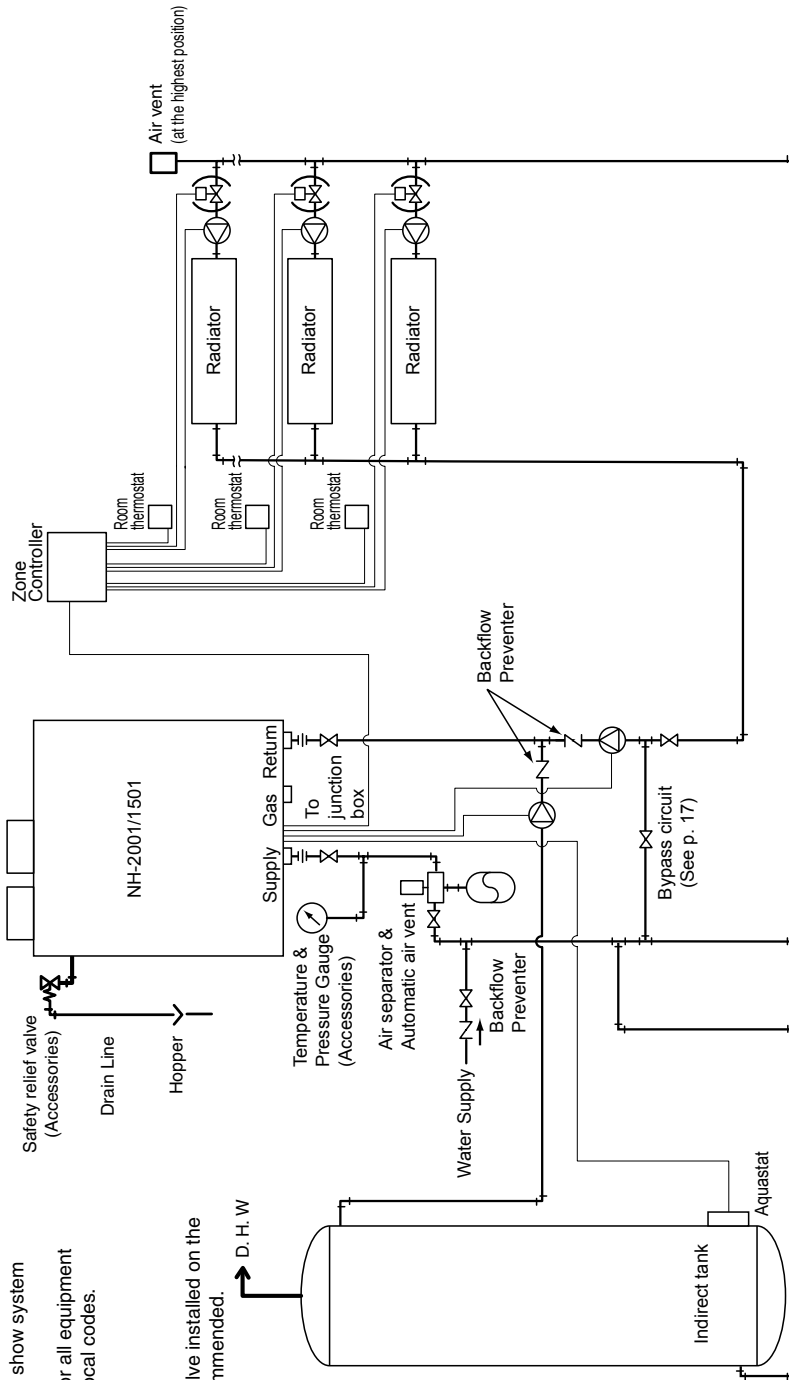

This drawing is meant to show system piping concept only. Installer is responsible for all equipment & detailing required by local codes.

An anti-scaled mixing valve installed on the DHW supply line is recommended.

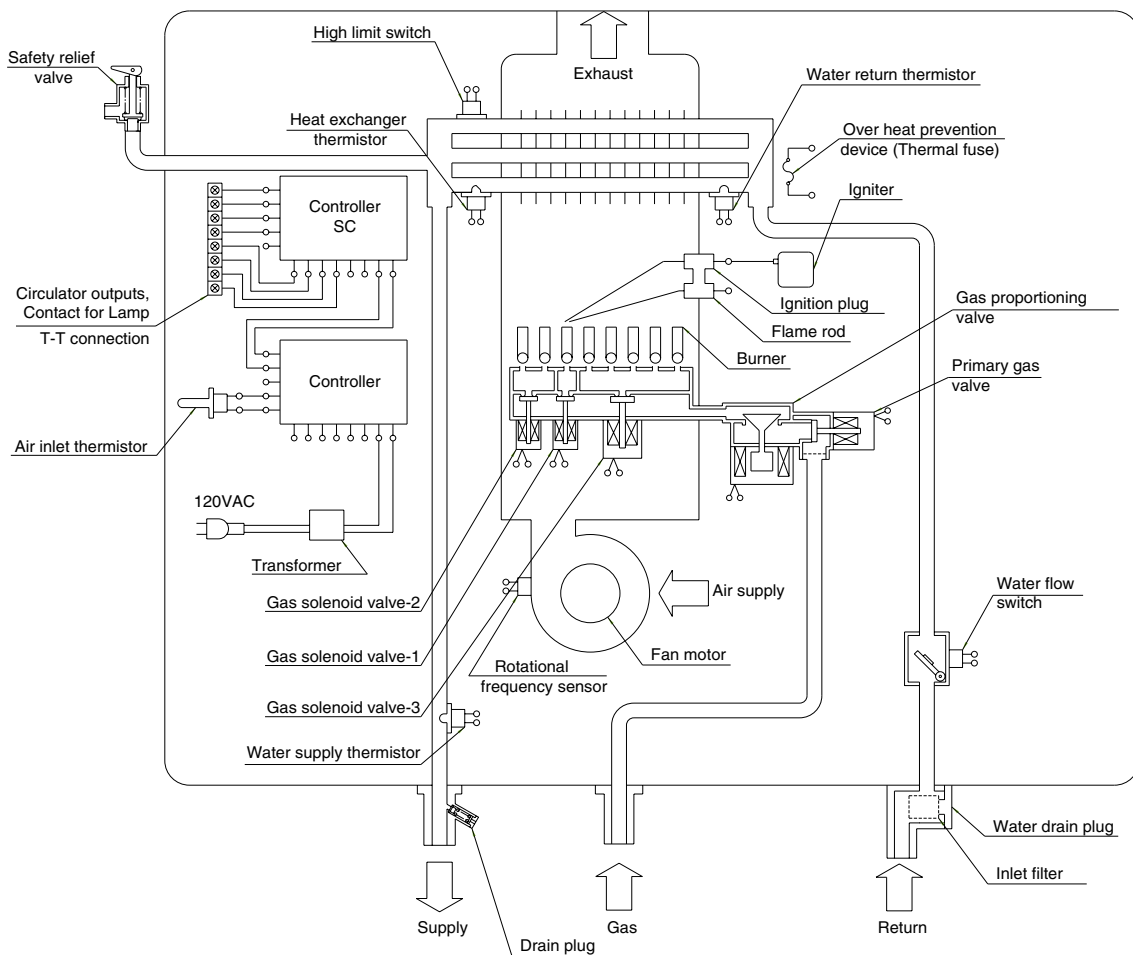

- The NH-2001-DV / NH-1501-DV is a boiler to be used for space heating or indirect water heating only. Do not use the hot water supplied by the boiler for drinking purposes.
- This boiler has a pressure rating of up to 150 psi, but it is designed to be used in a low pressure (15 psi) closed loop heating system. Use a 30 psi safety relief valve.
- The required heating load should not exceed the following ratings:
 NH-2001-DV: 135,000 Btu or below
 NH-1501-DV: 100,000 Btu or below
 The above values include a 15% allowance to provide for piping losses and pick up.
 * The boiler will stop automatically if the load surpasses these values greatly.
- When using anti-freeze, use Noritz approved anti-freeze only.
- The total flow rate of the heating circuit should be no less than 4 gpm (15 L/min.) and no greater than 17 gpm (65 L/min.).
- The return temperature should be 80°F (25°C) or greater.

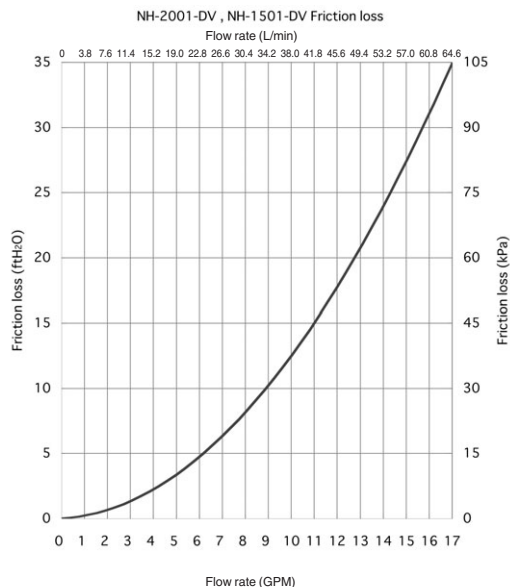

12. Electrical Wiring

Consult a qualified electrician for the electrical work.



Disconnect Power

Do not connect electrical power to the unit until all electrical wiring has been completed.

This appliance must be electrically grounded in accordance with local codes, or in the absence of local codes, with the National Electrical Code, ANSI/NFPA 70. In Canada, the latest CSA C22.1 Electrical Code.

Caution: Label all wires prior to disconnection when servicing controls. Wiring errors can cause improper and dangerous operation.

Verify proper operation after servicing.

Field wiring to be performed at time of appliance installation.

WARNING

Electrical Shock Hazard

Do not turn power on until electrical wiring is finished. Disconnect power before servicing. Failure to do so may result in death or serious injury from electrical shock.

- The electrical supply required by the boiler is 120VAC at 60 Hz. The maximum power consumption is 100W, not including the pump's power consumption. Be sure to use electric wiring suited for this power consumption.
- Do not turn off the power supply, even when not using the boiler. If the power is turned off, the freeze prevention function will not operate and the boiler could be damaged due to freezing.

- Do not let the power cord contact the gas piping.

Tie the redundant power cord outside the boiler. Putting the redundant length of cord inside the boiler may cause electrical interference and faulty operation.

Ground

- To prevent electrical shock, provide a ground with resistance less than 100Ω . An electrician should do this work.
- Connect the ground wire to the Ground terminal in the junction box.

Do not connect the ground to the city water or gas piping. Do not tie the ground to a telephone line.

Breaker Installation

- Mount a device which shuts off the electrical path automatically (GFCI) when electrical leakage is detected.

CAUTION

Electrostatic discharge can affect electronic components. Take precautions to prevent electrostatic discharges from personnel or hand tools during the boiler installation and servicing to protect product's electronic control.

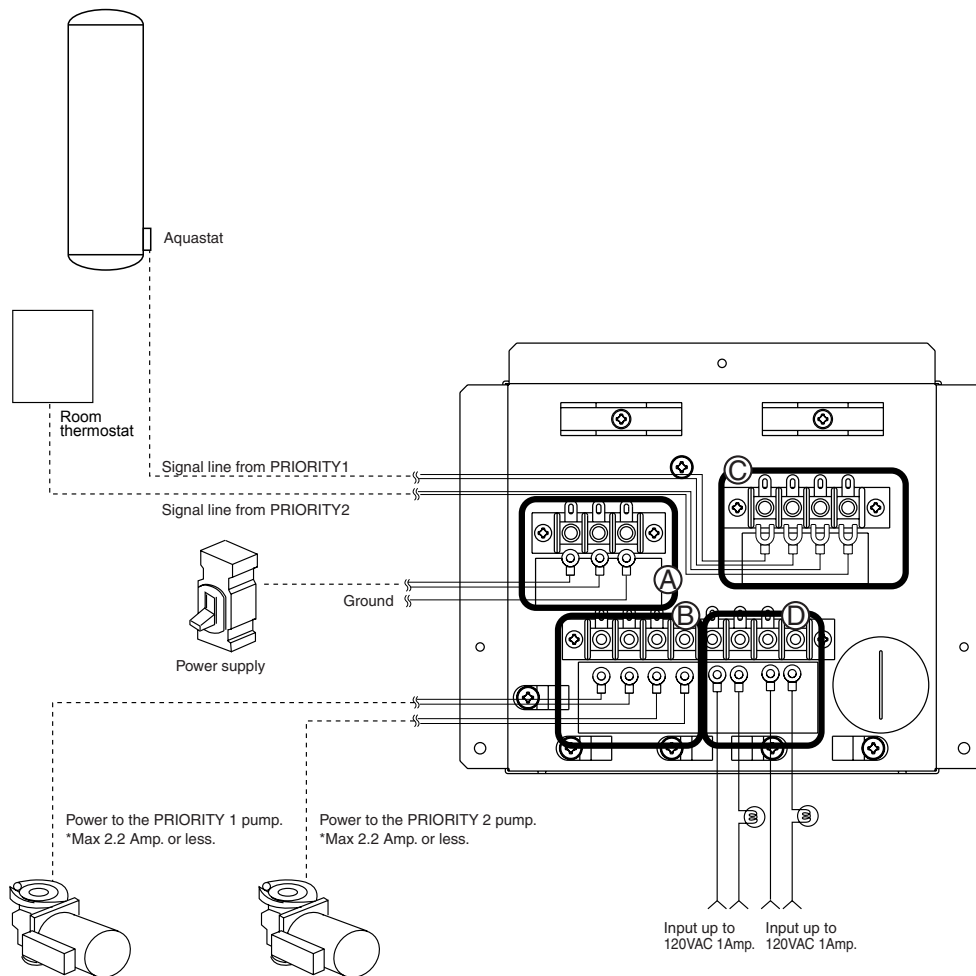

⚠ CAUTION

Electrical Cautions

- Connect the power to the circulating pumps to the terminal in the boiler.
- This model does not require a boiler protection loop.
- The unit may operate under cold weather conditions to prevent freezing.
- The freeze protection in this appliance relies on the ability to control the water that is circulating through it. In order to be protected from cold weather, please make sure that nothing will prevent the unit from being able to circulate water:
 - The freeze prevention in this appliance will not work if power is lost or disconnected, if power is not connected to the pump, if the pump is not connected to the unit, or if the pump fails.
 - Additionally, if any of the loops that the boiler is supplying hot water to is blocked or shut off, the freeze prevention may not be able to function properly.
- Connect the pump on the indirect water heating loop to the discharge side of the pump for the heating loop (See diagram)
- Use an aquastat on the indirect domestic water heating tank and connect it to the Priority 1 terminal inside the boiler. Connect the thermostat of the heating system to the Priority 2 terminal in the boiler.
- A 15 VDC, 0.1 Amp signal flows in the terminals. Use low Amp thermostats or zone controllers. 15 Amp devices may not operate properly.

A Power connection to the boiler.

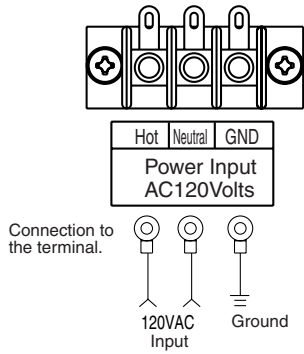

B Circulation terminal

■ Priority 1 (Indirect Tank)

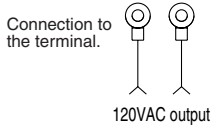
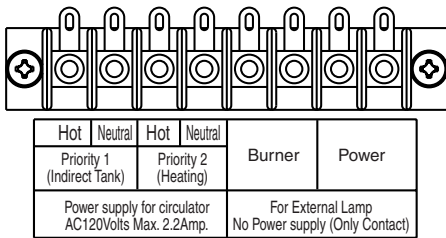

■ Priority 2 (Heating)

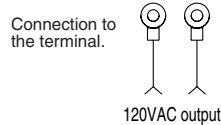
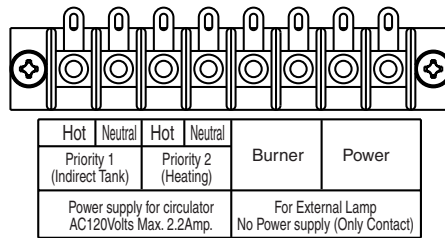

C Signal line connection

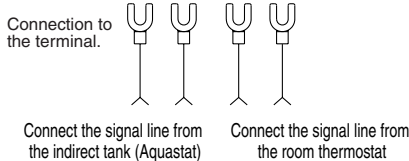
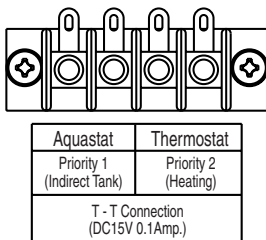

D External Lamp

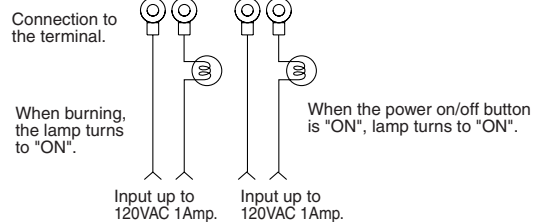
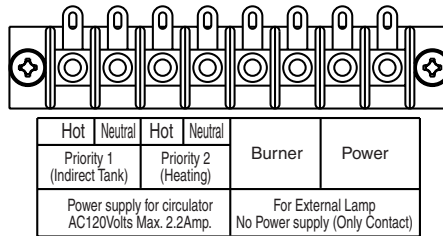

CAUTION

Pump Cautions

- Use the circulating pumps listed below or their equivalents. Add a pump if these are too small. The pump terminal in the unit is rated for 2.2 Amps. (See p. 25 for instructions for pumps that require greater than 2.2 Amps). Taco Model 0013:F3 (1/6 HP) Grundfos Model 26-99F (1/6 HP) Size the circulating pump based on the pressure loss of the boiler and the piping.
- Install the circulating pump near the return to the boiler.

Relay connection with larger pumps (>2.2 Amp.)

1. Instead of wiring the pump directly to the Priority 1 or Priority 2 terminals, wire a relay to the terminal as shown below.
2. Choose a suitable location for the relay where it will be protected from moisture.
3. Wire the power for the pump through the relay as shown below.

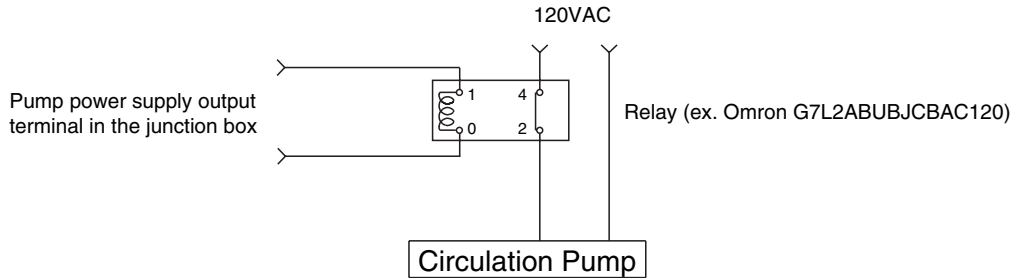

13. Maintenance

Periodically check the following to ensure proper operation of the boiler.

- The venting system must be examined periodically by a qualified service technician to check for any leaks or corrosion.
- The burner flame must be checked periodically for a proper blue color and consistency.
- If the flame does not appear normal, the burner may need to be cleaned.
- If the burner needs to be cleaned, it must be performed by a qualified service technician.
- Do not obstruct the flow of combustion and ventilation air.
- The pressure relief valve must be operated once a year to ensure that it is functioning properly and there is no obstruction.
- Turn the power off to the unit before opening the relief valve, and make sure that water draining out of the valve will not cause any damage.
- If the relief valve discharges periodically, it may be due to thermal expansion in a closed water system. Contact the water supplier or a local plumbing inspector on how to correct this situation. Do not plug the relief valve.
- Do not install air separators where negative pressure can develop in the system. Air will be drawn in. Install air separators at the highest level in the system.
- Inspect expansion tanks once a year to confirm there is enough air in them.
- Replace anti freeze every two years to prevent corrosion and clogging of the pipes.

Warning: There is a scald potential if the output temperature is set too high.

Should overheating occur, or the gas supply fail to shut off, turn off the manual gas control valve to the appliance. Do not use this appliance if any part has been under water. Immediately call a qualified service technician to inspect the appliance and to replace any part of the control system and any gas control which has been under water.

Periodically check and clean the filter inside the cold water inlet of the unit.

14. Trial Operation

The installer should test operate the unit, explain to the customer how to use the unit, and give the owner this manual before leaving the installation.

- Preparation (1) Open the gas supply valve.
(2) Turn on the power supply.

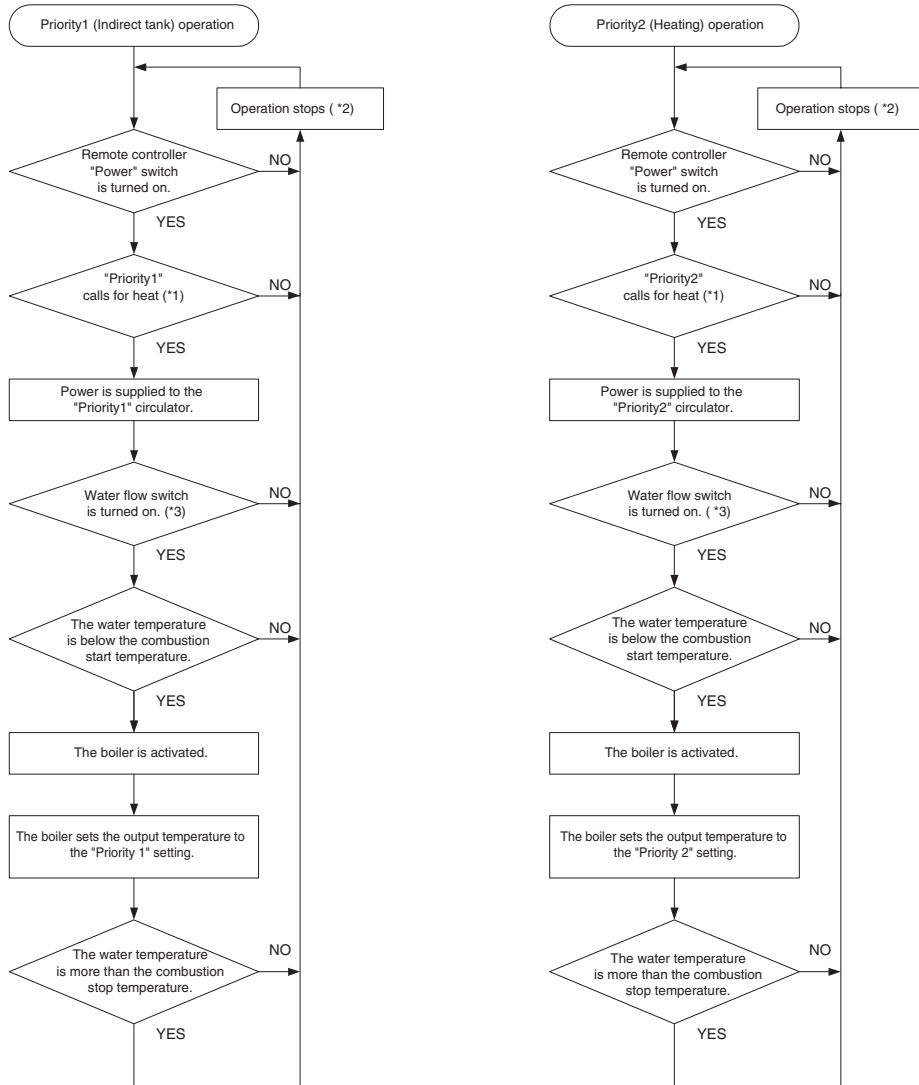

*1 When "Priority1" and "Priority2" both call for heat, the boiler gives priority to the "Priority 1" circuit.

*2 If the unit does not directly supply power to the circulator, an external control capable of providing a pump shut-off delay of 20 seconds or more must be used. Damage will occur to the boiler if the circulator shuts-off too soon after the burner shuts off.

When the boiler provides power directly to the circulator, it automatically allows the circulator to run for approximately 20 seconds after the burner shuts off.

*3 A flow rate of 2.5 GPM or more is required to activate the water flow switch. If the water flow switch is not turned on for a continuous 60 seconds, boiler operation is stopped.

• Error message "113" may be displayed at first until the air is bled from the gas piping.

If error message "113" is displayed, set the POWER switch to the off position, then set it back to the on position.

* White smoke may be noticed from the exhaust vent during cold weather. However, this is not a malfunction of the unit.

• If the boiler does not operate normally, refer to "Troubleshooting" in the user's information manual.



CAUTION

Handling after trial operation

<When Using Anti-Freeze>

- When not planning to use the boiler immediately, close the gas and water shutoff valves to prevent gas leakage from the boiler.
- Drain a little boiler water from the drainage shutoff valve, check the pressure, then attach the "CONTAINS ANTI-FREEZE" part of the label to the boiler's front panel.
- * When using anti-freeze, we recommend stopping the freeze prevention function. (See p. 29 "Other Settings")

<When Not Using Anti-Freeze>

- If the unit will not be used immediately, close off all gas and water shutoff valves, drain all of the water out of the unit and the plumbing system to prevent the unit and system from freezing, and bleed the gas out of the gas line.
- Freezing is not covered by the warranty.



WARNING

A fire or explosion may result if these instructions are not followed, which may cause loss of life, personal injury or property damage.

Lighting Instructions

This boiler does not have a pilot. It is equipped with an ignition device that automatically lights the burner. Do not try to light the burner by hand.

1. Read the safety information in the installation and instruction manual or on the front of the boiler.
2. Turn off all electrical power to the unit.
3. Do not attempt to light the burner by hand.
4. Turn the gas control manual valve (external to the unit) clockwise to the off position.
5. Wait five minutes to clear out any gas. If the smell of gas remains, stop, and follow the instructions on page 3 of user's information manual.
6. Turn the gas control manual valve counterclockwise to the on position.
7. Turn on electric power to the unit.
8. The unit will now operate whenever hot water is called for. If the unit will not operate, follow the shutdown instructions and call a service technician.

Shutdown Instructions

1. Stop any water demand.
2. Turn off electric power.
3. Turn the gas control manual valve clockwise to the off position.

Should overheating occur or the gas supply fail to shut off, do not turn off or cut the power supply to the pump. Instead, close the gas shutoff valve on the outside of the boiler.

Safety shut off

1. Operate the boiler.
2. Close the gas shutoff valve.
3. Check that error message "123" is displayed. (It takes about 90 seconds.)
To clear the error records that occur during trial operation, set the power on/off switch to the off position and press and hold in the ▼ setting switch on the operation panel for about 5 seconds. A beep is sounded and the error records are reset.

15. Dimensions

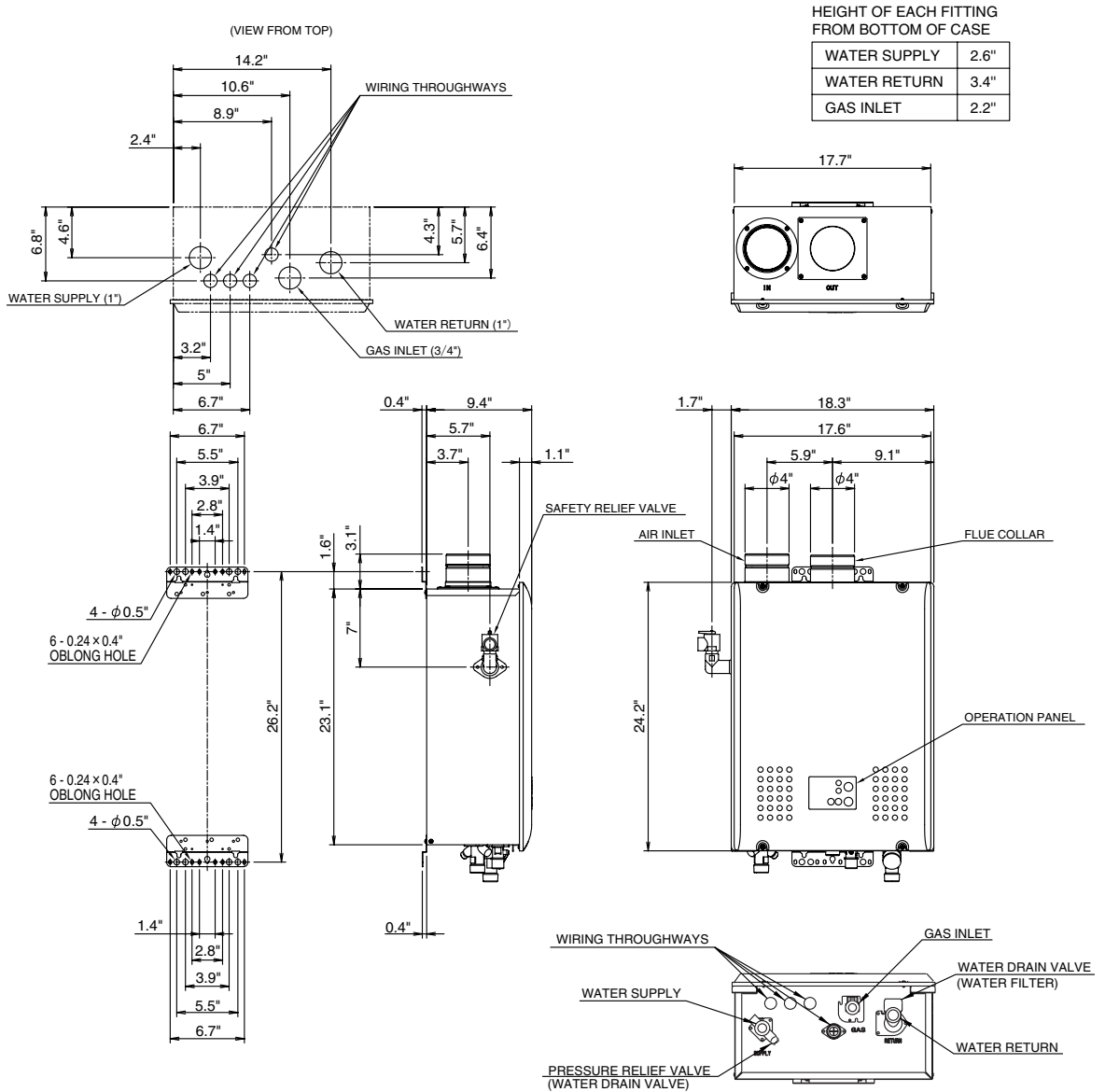

16. Other Settings

Manual Pump Operation Procedure

Use this procedure when bleeding air out of the system or when confirming proper operation of the pump(s).

1. Set the Power on/off button to the off position.
 2. To circulate Priority 1, press and hold in the PRIORITY 1 switch for at least 5 seconds.
To circulate Priority 2, press and hold in the PRIORITY 2 switch for at least 5 seconds.
 3. "P" flashes on the display and "of" lights.
 4. "of" turns to "on" when the circulation flow rate reaches above the flow rate at which the water flow switch turns on.
 5. The pump stops either when the corresponding PRIORITY switch is pressed again or after 4 hours.
The pump also stops if the Power on/off button is set to the on position.
- * The pump turns off if the water flow switch does not turn on after 5 minutes.
Set the flow rate as described on page 17.

Changing Other Features

Note:

- Set the Power on/off button to the off position when changing the settings.
The settings cannot be changed unless the boiler is turned off on the operation panel before disconnecting power.
- Change the settings within 10 minutes of reconnecting power to the boiler.
- If the temperature display is set to the Fahrenheit mode, item number "1" is not displayed; "180" is displayed instead.
- Settings cannot be changed during manual pump operation mode.
- Item number 1 (Priority 1 maximum temperature setting) alone can be set at any time.

Table of Setting Items

Item No.	Item	Choices (factory defaults shaded)			Remarks
1	Priority 1 maximum temperature setting.	140 to 170°F (5°F steps) 176, 180°F (180°F by factory default)	60 to 80°C (5°C steps) 83°C.	When item no. 13 is set to "oF", item no. 1 is not displayed. Because the display is set to the Fahrenheit mode by factory default, "180" °F is displayed for item 1.	
12	Celsius/Fahrenheit display mode.	°F (Fahrenheit) ▲	°C (Celsius) ▼		
13	Priority 1 operation setting.	on (on) ▲	oF (off) ▼	When set to "oF", Priority 1 does not operate.	
14	Priority 2 operation setting.	on (on) ▲	oF (off) ▼	When set to "oF", Priority 2 does not operate.	
15	Freeze prevention function.	1 (combustion on/ pump circulation on)	2 (combustion off/ pump circulation on)	3 (combustion off/ pump circulation off)	When using anti-freeze, it is recommended you change this setting to "3".
16	Displayed temperature selection.	1 (set temperature)		2 (circulation temperature)	When changed to 2, the circulation temperature is displayed.

Operation Panel

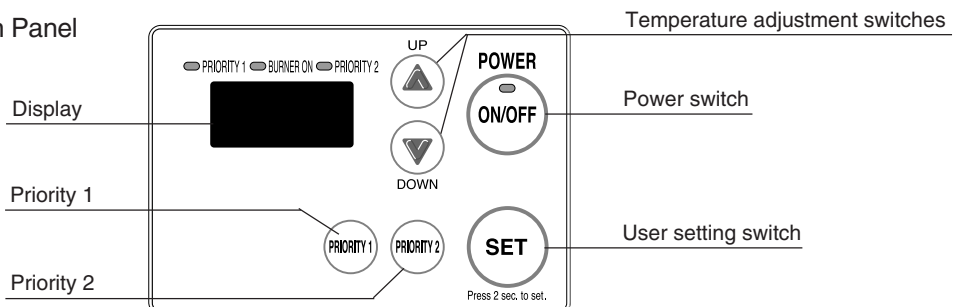

Setting Procedure

1. Set the Power on/off button to the off position.
2. Disconnect, then reconnect power to the boiler.
3. Press the user setting switch (SET) and hold it in for 2 seconds or more.
4. Press the user setting switch (SET) to select the number of the item to be changed.
5. Use the ▲ and ▼ temperature adjustment switches to change the selected item.
6. Once all settings are finished, set the Power on/off button to the on position to validate the settings.

Error descriptions and possible cause / check points

Error Code	Possible Cause	Check Point (Location of Failure)
113	Ignition failure	Is the gas valve closed? Does the igniter spark? Are all wiring connections to the gas valves secure? Is the lead from the flame rod securely connected?
123	Flame rod is triggered	Is the gas valve closed? Are all wiring connections to the gas valves secure? Is the lead from the flame rod securely connected?
163	Hot water temperature does not stabilize	The heating load might be too large. Is the hot water temperature higher than 131°F (55°C) or more? If the hot water temperature is lower than 131°F (55°C), adjust the flow in the heating circuit and/or check the temperature setting on the operation panel.
633	PRIORITY 1 pump abnormality, water flow switch failure	Is the pump running? Is the fuse inside the boiler blown? Is the wiring for the flow switch properly connected?
643	PRIORITY 2 pump abnormality, water flow switch failure	Is the pump running? Is the fuse inside the boiler blown? Is the wiring for the flow switch properly connected?
733	Circuit board setting abnormality, high elevation connector	This error code is displayed when the high elevation connector is disconnected or connected while the boiler has power. Disconnect power to the boiler before making this adjustment.
903	Abnormal combustion	Check if there is any obstruction of the intake/exhaust pipe.

The error codes in bold cannot be reset by turning the boiler OFF on the operation panel. Disconnect, then reconnect electrical power to the boiler to reset the system. Please contact Noritz America if any other error code appears.

